

# SX-828

FW  
FVZW  
KCUW

PIONEER

SX-828

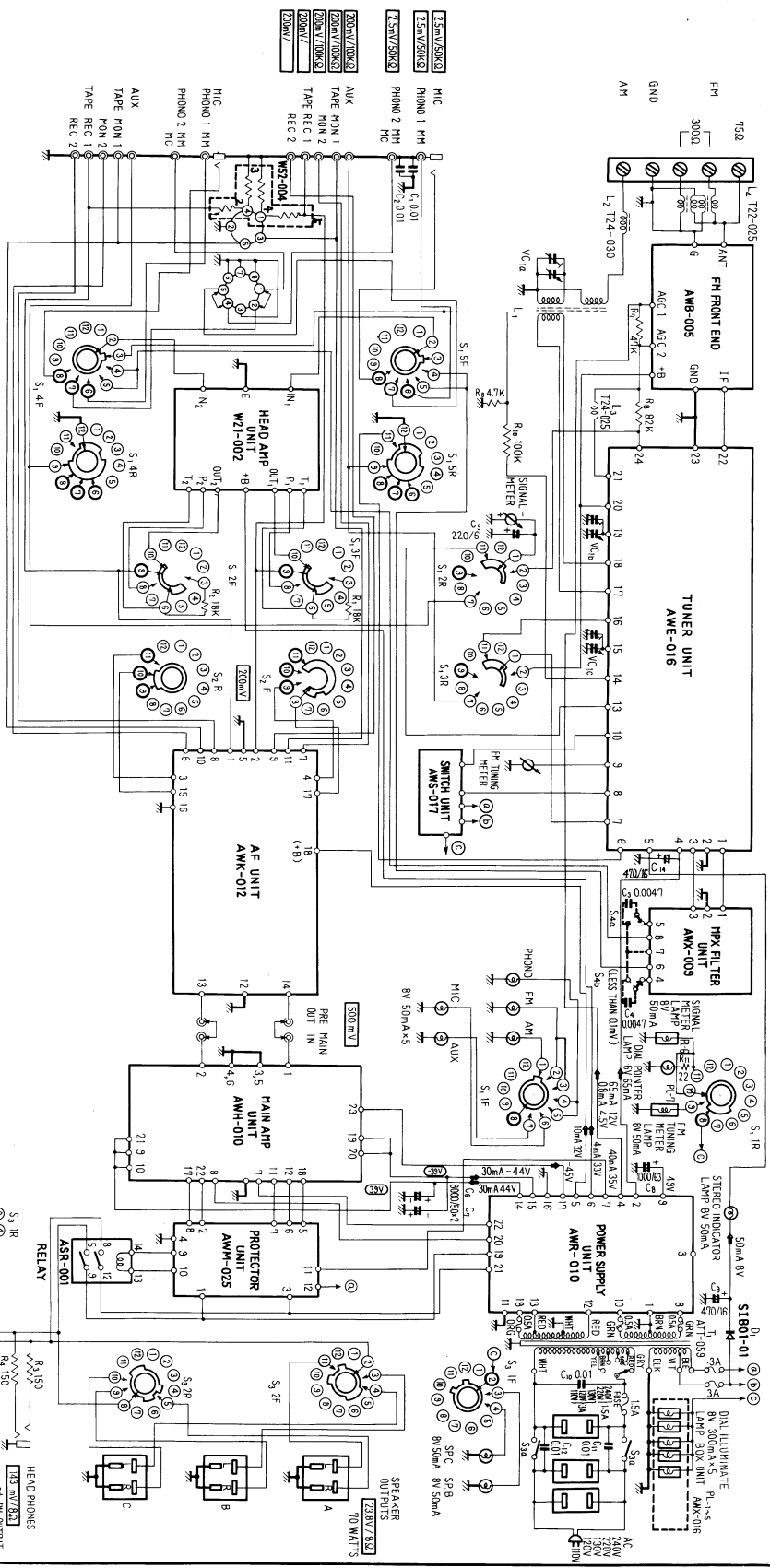

- S1 INPUT SELECTOR**
- 1 AM MONO
  - 2 FM MONO
  - 3 FM AUTO
  - 4 PHONO 1
  - 5 PHONO 2
  - 6 MIC
  - 7 AUX
- S2 MODE SELECTOR**
- 1 REVERSE
  - 2 STEREO
  - 3 LEFT
  - 4 RIGHT
  - 5 L+R
- S3 OUTPUT SELECTOR**
- 1 POWER OFF
  - 2 SPEAKER A
  - 3 SPEAKER B
  - 4 SPEAKER C
  - 5 SPEAKER A+B
  - 6 SPEAKER A+C
  - 7 DITHM
- OTHER SWITCHES**
- |                 |      |        |       |
|-----------------|------|--------|-------|
| TAPE MONITOR    | 1, 2 | OFF    | → ON  |
| FM MUTING       |      | ON     | → OFF |
| AUDIO MUTING    |      | OFF    | → ON  |
| LOUDNESS        |      | OFF    | → ON  |
| LOW CUT FILTER  |      | OFF    | → ON  |
| HIGH CUT FILTER |      | OFF    | → ON  |
| BRIGHT          |      | → DITH |       |
- ALL VALUES ARE MEASURED WITH V.T.V.M.

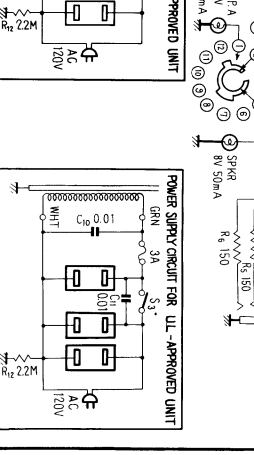
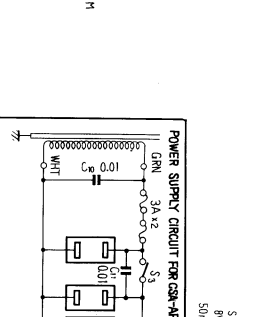
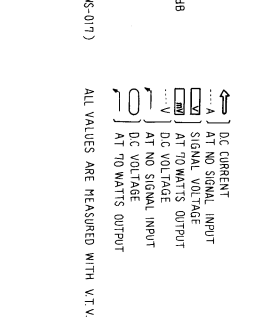

NOTES:

- Neither switch (S2) nor capacitors (C1-C4) are provided for FITZ-approved unit.
- No switch (S2) is provided for 120V unit, but capacitors (C3 & C4) are provided.



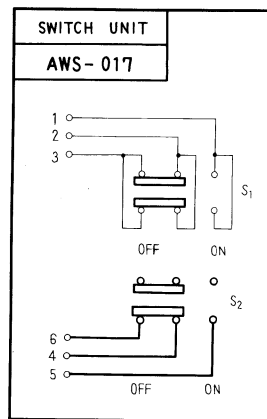
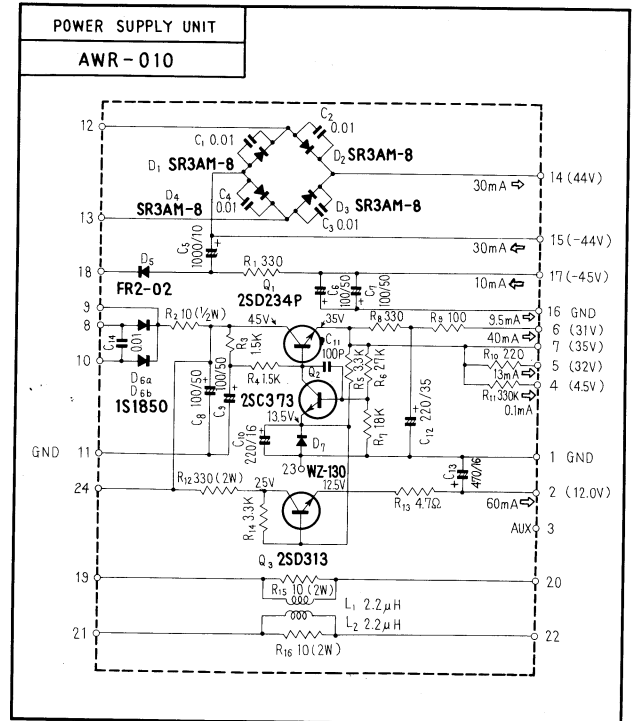
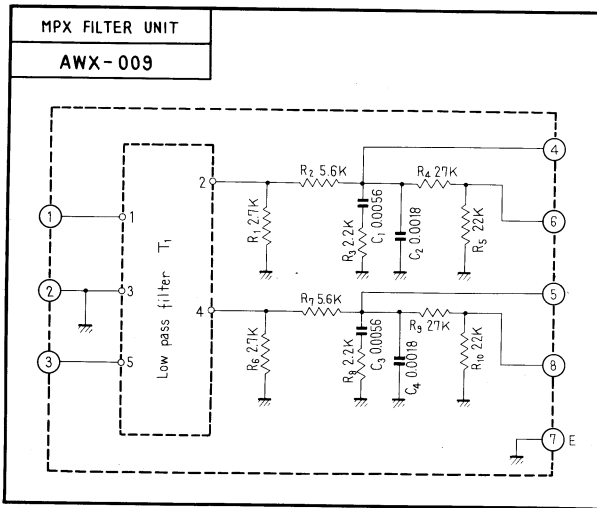
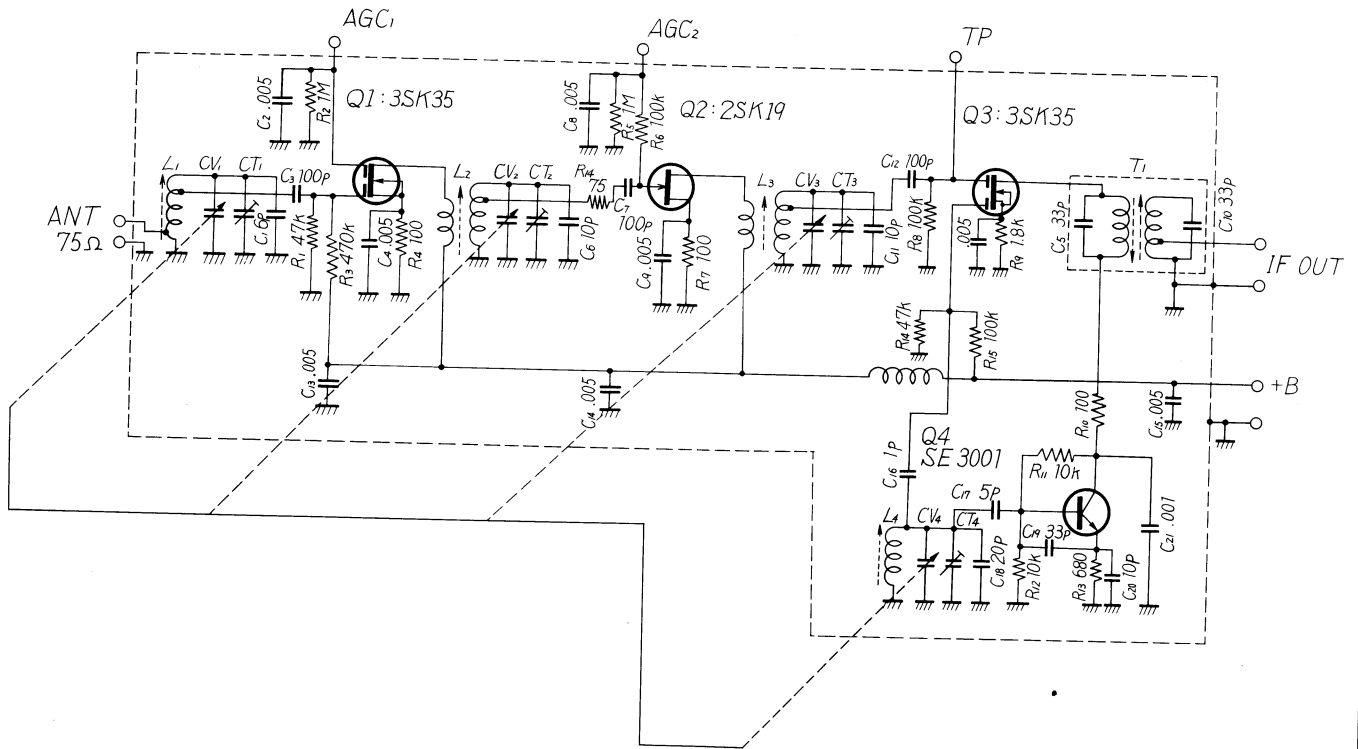



NOTES :  
 • Neither switch (S<sub>4</sub>) nor capacitors (C<sub>1</sub>, C<sub>2</sub>) are provided for FTZ-approved unit.  
 • No switch (S<sub>4</sub>) is provided for 120V unit, but capacitors (C<sub>3</sub> & C<sub>4</sub>) are provided.

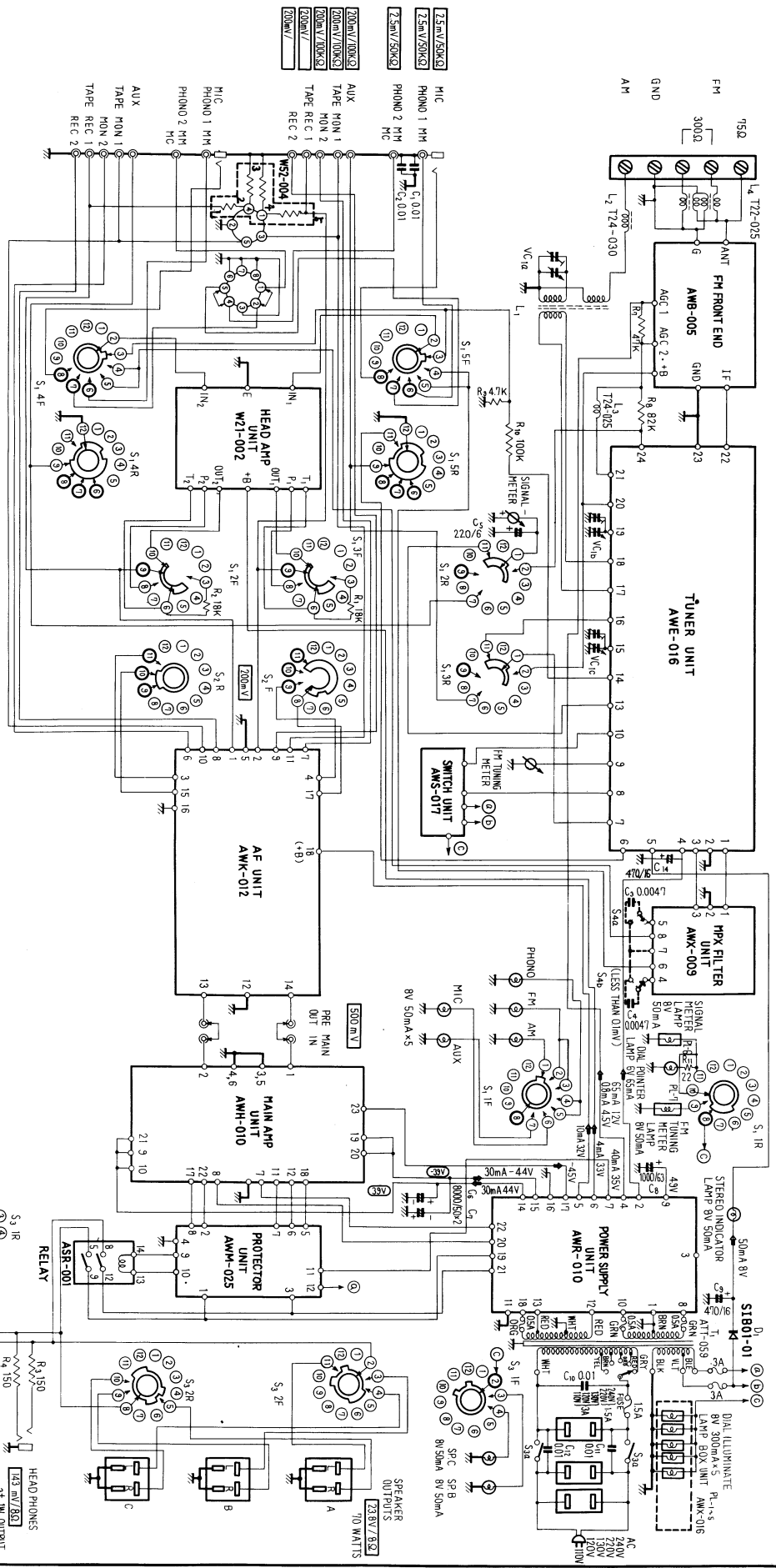

- S<sub>1</sub> INPUT SELECTOR
- 1 AM
  - 2 FM MONO
  - 3 FM AUTO
  - 4 PHONO 1
  - 5 PHONO 2
  - 6 MIC
  - 7 AUX

- S<sub>3</sub> OUTPUT SELECTOR
- 1 POWER OFF
  - 2 SPEAKER A
  - 3 SPEAKER OFF
  - 4 SPEAKER B
  - 5 SPEAKER C
  - 6 SPEAKER A+B
  - 7 SPEAKER A+C

- OTHER SWITCHES
- TAPE MONITOR 1, 2 OFF → ON
- FM MUTING ON → OFF
- AUDIO MUTING OFF → -20dB
- LOUDNESS OFF → ON
- LOW CUT FILTER OFF → ON
- HIGH CUT FILTER OFF → ON
- DITHERK BRIGHT → DIM

- ALL VALUES ARE MEASURED WITH V.T.V.H
- ← DC CURRENT
- AT NO SIGNAL INPUT
- ⊖ SIGNAL VOLTAGE
- ⊖ AT 70 WATTS OUTPUT
- ⊖ DC VOLTAGE
- ⊖ AT NO SIGNAL INPUT
- ⊖ DC VOLTAGE
- ⊖ AT 70 WATTS OUTPUT

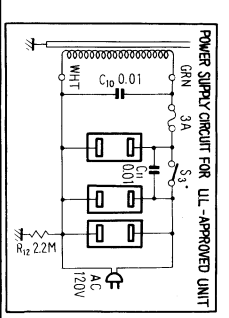
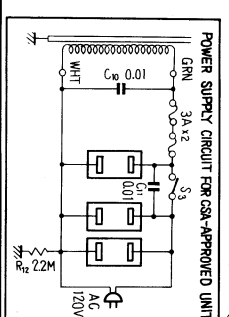

AF UNIT

AWK-012

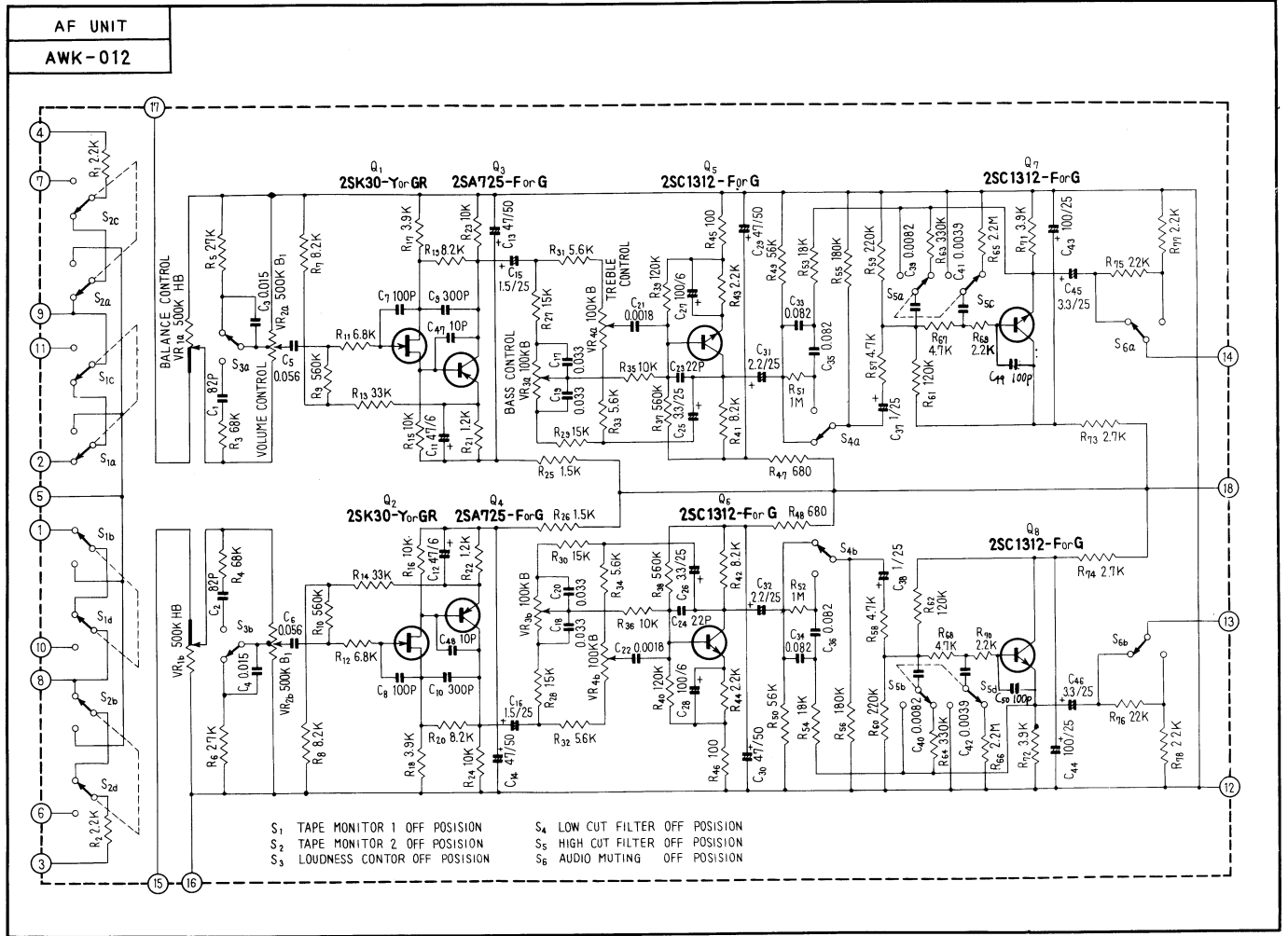

HEAD AMP UNIT

W21-002

Q<sub>1</sub>-Q<sub>6</sub> 2SC1312 or 2SC1344

